

COMPARISON OF CAPILLARY AND SKIMMER INTERFACES IN EVOLVED GAS ANALYSIS-MASS SPECTROMETRY (EGA-MS) WITH REGARD TO IMPURITIES IN CERAMIC RAW MATERIALS

T. Tsugoshi, M. Furukawa, M. Ohashi and Y. Iida

Material Characterization Laboratory, Ceramic Science Department, National Industrial Research Institute of Nagoya, 462-8510 Nagoya, Japan

Abstract

Capillary and skimmer interfaces in EGA-MS were compared by analysis of the carbon substances remaining in the hydrolysis products of aluminum alkoxides. Peaks with higher intensities were detected in the skimmer interface mode than those in the capillary interface mode. It was confirmed in particular that the skimmer interface is effective in increasing the sensitivity for species with higher mass, e.g. the evolved butyl group, as carbon substances remaining in the hydrolysis product of aluminum *sec*-butoxide.

Keywords: Al alkoxides, capillary interface, EGA-MS, skimmer interface, sol-gel method

Introduction

The impurities in the starting materials of fine ceramics have received increasing attention in recent years, since these impurities exert considerable effects on such features as the sintering process, the properties of the final products, etc. The sol-gel technology that is widely used for the synthesis of fine ceramic starting materials can result in residual carbon substances due to the hydrolysis of aluminum alkoxides, though the residual amount is very small. In a previous report, our trial EGA-MS apparatus successfully detected the carbon substances evolved during the elimination process [1]. However, there is a possibility that heavier gaseous species evolved at high temperatures ($>200^{\circ}\text{C}$) are less readily detectable, since the capillary interface temperature was 200°C . In the present study, we have compared the capillary and skimmer interfaces between a heating furnace (atmospheric pressure) and a vacuum chamber with a mass spectrometer. For comparison of the difference due to the interfaces, we used infrared image furnaces of the same type and the same vacuum chamber.

Experimental

The EGA-MS instrument was constructed with a gold image furnace (MR-39H, Shinku-Riko) and a quadrupole mass spectrometer (AQA-360, Anelva). In the capillary interface mode, as shown in Fig. 1, the two devices were connected by a stainless-steel capillary treated with dimethylsiloxane (UADTM-5N, Frontier Lab). Its length and inner diameter were 700 and 0.15 mm, respectively. The pathway of the gaseous species was heated at 200°C. The carrier gas was high-purity helium, with a liquid nitrogen pool to trap traces of water and other impurities. In the skimmer interface mode, as shown in Fig. 2, two conical quartz tubes with orifices connected the two devices at atmospheric pressure or under vacuum. Since the carrier gas used was also high-purity helium, the evolved gaseous species with higher masses were enriched after the second orifice, in consequence of the principle of a jet separator. The quartz tube received no special heating, except infrared radiation from the furnace lamp and radiant heat from the sample. In fact, the image furnaces in the capillary and skimmer modes were subtly different. While a single lamp was used in capillary mode, a double lamp was used in skimmer mode because we were afraid that the skimmer would make a shadow which would lower its maximum temperature.

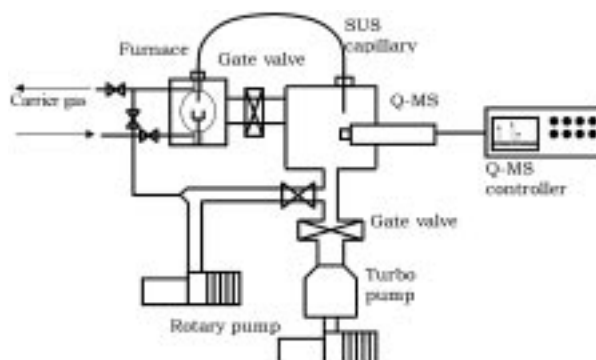

Fig. 1 Schematic diagram of the instrumental model EGA-MS apparatus in capillary mode

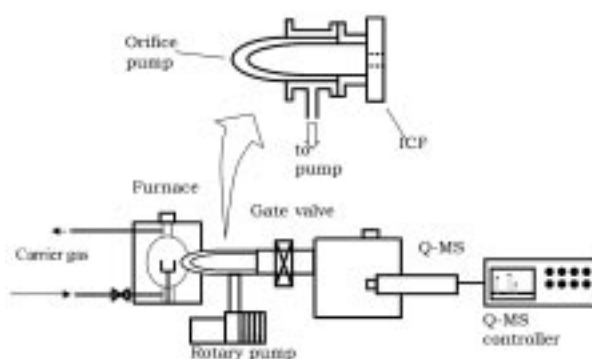

Fig. 2 Schematic diagram of the instrumental model EGA-MS apparatus in skimmer mode

As concerns sample preparation, we refer to a report [2] on sol-gel processing as follows: the molar ratio between the alkoxide and water was kept at 1:100 in all cases. The hydrolysis was carried out with deionized and distilled water kept at the hydrolysis temperature. The hydrolysis temperature was kept at 90°C with a water bath. The precipitates were suction-filtered, washed with the alcohol that corresponded to its alkoxyl group, and dried with CaCl_2 at the hydrolysis temperature.

Results and discussion

Figure 3 shows that the hydrolysis product of Al isopropoxide at 90°C was confirmed by the XRD data (JCPDS:21-1307) to be (pseudo)boehmite. Analogous spectra were obtained from the Al hydroxides from the methoxide, ethoxide and *sec*-butoxide. As regards the hydrolysis product at 90°C, water in the crystal structure leads to a distortion of the boehmite structure. It has been described as 'pseudoboehmite' [3].

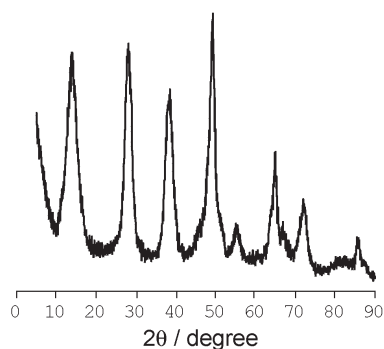

Fig. 3 XRD spectrum of hydrolysis products of Al isopropoxide at 90°C

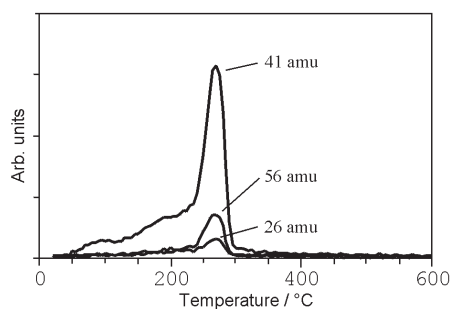

Fig. 4 Capillary mode EGA-MS curves obtained from 90°C hydrolysis product of Al methoxide

Figures 4 and 5 show EGA-MS curves obtained from the hydrolysis product of Al methoxide at 90°C with capillary and skimmer interfaces, respectively. The mass numbers of 26, 41 and 56 amu are due to residual alkoxy group. The intensities of all EGA curves in this paper are normalized vs. the sample amount and the measurement

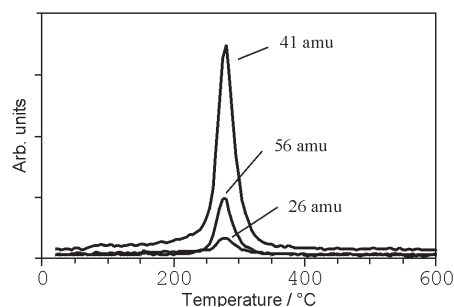

Fig. 5 Skimmer mode EGA-MS curves obtained from 90°C hydrolysis product of Al methoxide

range of the mass spectrometer. While the methoxy group should evolve 15 amu as CH_3 , the heavier species C_2H_2 (26 amu), C_3H_5 (41 amu) and C_4H_8 (56 amu) were detected. This is due to polymerization of the methoxy group in Al methoxide [4]. In the case of the hydrolysis product of Al ethoxide at 90°C, as shown in Figs 6 and 7, only C_2H_2 (26 amu), due to the residual ethoxy group, was detected. The species 41 and 56 amu were not detected because polymerization of the ethoxyl group does not occur in Al ethoxide. The hydrolysis product of Al *sec*-butoxide at 90°C reveals desorption of the *sec*-butyl group. The ratio of the intensities of 56 amu vs. 41 amu was higher than those obtained from the other samples. This is due to the residual *sec*-butoxy group.

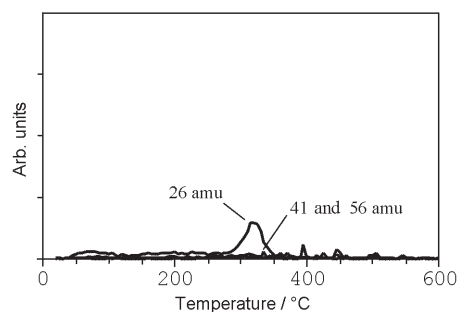

Fig. 6 Capillary mode EGA-MS curves obtained from 90°C hydrolysis product of Al ethoxide

Table 1 compares the intensities of the peaks in the EGA-MS curves. The intensities of the peaks obtained with the skimmer interface are a little higher than those obtained with the capillary interface as concerns the hydrolysis products of Al methoxide, ethoxide and isopropoxide. This is due to the fact that most gaseous species, including helium as carrier gas, are guided into the interface via its first orifice while most gases are exhausted in the case of the capillary interface. In particular, there is an appreciable difference in the intensities of the peaks obtained from the hydrolysis product of Al *sec*-butoxide with heavier mass.

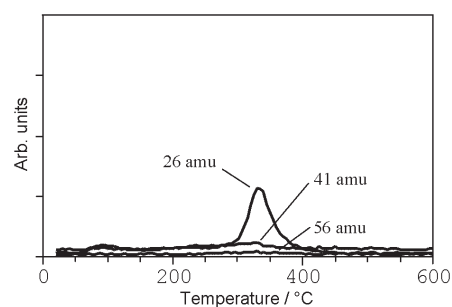

Fig. 7 Skimmer mode EGA-MS curves obtained from 90°C hydrolysis product of Al ethoxide

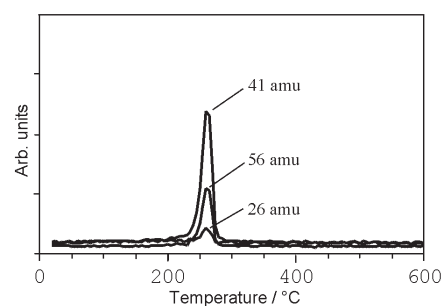

Fig. 8 Capillary mode EGA-MS curves obtained from 90°C hydrolysis product of Al *sec*-butoxide

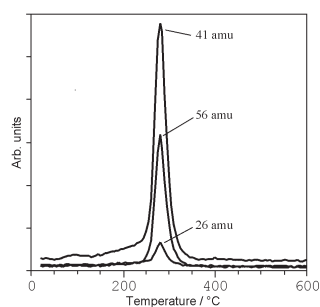

Fig. 9 Skimmer mode EGA-MS curves obtained from 90°C hydrolysis product of Al *sec*-butoxide

Table 1 Peak intensities of EGA-MS curves. All intensities are normalized vs. a sensitive range and sample amount

	Methoxide			Ethoxide	Isopropoxide	<i>sec</i> -Butoxide			
	26	41	56	26	41	26	41	56	
	amu								
Capillary	0.30	3.14	0.71	0.59	0.41	0.43	2.39	1.10	
Skimmer	0.34	3.49	0.98	1.12	0.47	0.66	5.78	3.18	

Conclusions

It has been confirmed that the skimmer interface is effective in increasing the detection sensitivity, especially in a higher mass range. A feature of our skimmer interface is the low cost. Furthermore, it can be used for high-speed heating because an infrared image furnace is utilized. However, our apparatus has the problem that the ionization point is not on the axis connecting the two orifices of the skimmer interface. When the problem of vacuum chamber design is solved, it is expected to yield more sensitive data.

References

- 1 T. Tsugoshi, M. Furukawa, M. Ohashi and Y. Iida, *Anal. Sci.*, 15 (1999) 327.
- 2 R. I. Zakharchenya and T. N. Vaislevskaya, *J. Mater. Sci.*, 29 (1994) 2806.
- 3 D. Papee, R. Fertian and R. Biaï, *Bull., Soc. Chem. France*, (1958) 1301.
- 4 D. C. Bradley, R. C. Mehrotra and D. P. Gaur, 'Metal alkoxides', Academic Press, London 1978.